

The Inland Koi Connection



THE OFFICIAL
NEWSLETTER
OF IKS
ISSUE 163
OCTOBER 2009

OCTOBER 25, 2009

**Sunday - 2-5 PM / IKS General Meeting
& Potluck Lunch at the home of
RICK & MARYLIS WHIPPLE
18590 Roberts Road ~ Riverside, CA 92508**



(951) 789-0527





Hi Everybody,
 We had another great meeting in September at the home of Jim and Earlene Hearn. There were fifty two members at the meeting, which was a lot because many of our members were away on vacation. Jim has a nice pond with some big fish, and we all enjoyed his talk about the pond. Thank you, Jim and Earlene, for hosting the meeting. I really appreciated Jim because he was the only person at the meeting with less hair than me. (Facial hair does not count.)

Michele McKinney Underwood, from the Western Municipal Water District, was the speaker; she discussed the water situation and our lack of it. One of the items mentioned was the ‘stage-4 water alert’ under which people are not allowed to operate ponds and decorative fountains. Michele wasn’t sure about how that applied to koi ponds, and said that she would look into it. She later e-mailed us to inform us that if a pond is “purposefully maintained as a habitat for fish or other aquatic life, it would be exempt from unreasonable restrictions.” I guess our koi can rest a little easier now.

It’s fall now and the water in our ponds will start to get cooler and our koi will become less active. No more spawning until next spring. However, I’m excited this fall because I’m looking forward to a freeway series with the Angels beating the Dodgers in the World Series. Anybody want to bet a koi on it?

Fall also means that it’s almost election time for our club officers and board members; voting will take place at our November meeting. In addition to our elected officers, there are also other jobs that need to be filled for next year. If anyone would like to take over the library or bring drinks to our meetings, please let me know.

Our next meeting will be at the home of Rick and Marylis Whipple in Riverside. They are fairly new members of the club and I hear that they have a nice big interesting pond. Since it is now fall and hopefully cooler but dry for the meeting, the schedule will go back to the 2:00 PM to 5:00 PM format. The speaker will be Kirk Taylor, who is president of the Turtle Club. He will bring a number turtles and talk about them. They have a turtle rescue program similar to our koi rescue, so if you are interested in adding a turtle to your pond, I’m sure he can get you one.

Also at this meeting, we will start getting ready for our club’s world famous Thanksgiving celebration at the November meeting. There will be a reservation list so our hosts know how many to expect, and you can sign up to bring your favorite Thanksgiving dish for our pot luck.

So, bring your chairs and something for the pot luck and be prepared to have some fun, learn something about turtles, and enjoy the friendship of your fellow club members.

See you at the meeting.

Mark

Mark Krakower – IKS president.



BOARD of DIRECTORS Inland Koi Society 2009		Inside this issue	
<u>PRESIDENT:</u> MARK KRAKOWER (951) 371-2223 kraktronix@sbcglobal.net		•Oval Pond •Board Members •Help Line	2
<u>VICE PRESIDENT:</u> DENNIS LYNAUGH (951) 780-0123 dlynaugh@pacbell.net		•Monthly Profile •Map •Directions	3
<u>SECRETARY:</u> ZUMA ROSS (951) 354-6444 zumaross@charter.net		•Beware / Friends •Harrison’s Koi •Sept. Meeting Notes •Laguna Koi •Waterscapes	4/5
<u>TREASURER:</u> NICK MILFELD (951) 780-7395 milfeld@msn.com		•Pondable •Elections •Turkey Time •Love	6/7
<u>NEWSLETTER EDITOR:</u> DEBBY LEVERETT (951) 781-3887 jenniferdl1950@hotmail.com		•Inland Koi •Mazuri Diets	8
<u>DIRECTOR:</u> KELLY HOUSTON (909) 885-2503 vpkelly@earthlink.net		•New Members •Leo’s Construction •2 Koi Guys •MarLu Designs •Living Smart, LLU	9
<u>DIRECTOR:</u> ED KUSHNER (951) 520-0092 edkushner@msn.com		•W. Lim Corporation •Dragon Series •Wave Pumps	10
<u>DIRECTOR: Raffle Manager</u> MARY LEEVER (909) 862-3028 mary@leeverelectronics.com		•Calendar / Events •Full Moon House •Edward Dean Jazz •Program Planning	11
<u>DIRECTOR:</u> GENE MAINGOT (951) 272-4450 gomaingo@sbcglobal.net			
<u>DIRECTOR:</u> JACK MARRIN (909) 792-3603 jack@marrin.com			
<u>DIRECTOR: Member Database</u> TOM ROSS (951) 354-6444 tomzuma@charter.net			
<u>DIRECTOR:</u> TOM WRIGHT (951) 637-5479 rookiekoiguy@earthlink.net			
~HELP LINE~ REFERENCES			
• KOI DISEASE:	TOM ROSS	(951) 354-6444	
• INFORMATION:	JACK MARRIN	(909) 792-3603	
• LIBRARIAN: Books, Videos	TEE WRIGHT	(951) 637-5479	
• MEETING SITES:	KELLY HOUSTON	(909) 885-2503	
• MEMBERSHIP:	TEE WRIGHT	(951) 637-5479	
• NEWSLETTER ADS:	DEBBY LEVERETT	(951) 781-3887	
• PLUMBING or FILTERS:	BOB WALTERS	(951) 681-4064	
• RAFFLE MANAGER:	MARY LEEVER	(909) 862-3028	



Our October meeting hosts, Rick and Marylis Whipple, live on two acres in Riverside and have an awesome pond. They will have plenty of room for us with open grass space on a lower level by the pond and above looking down on the pond. The beautiful metal gazebo Rick built extends out from the upper level of their property to the edge of the pond which is on the lower level, but the gazebo is about twelve to fifteen feet above the surface of the pond. This gives a dramatic affect to the whole landscape. The Whipples have about fifty koi in the main pond and Rick feeds them from the gazebo. He calls them by stomping his feet; the sound echoes and the fish, hearing the noise, swim to the edge of the pond under the gazebo to eat.

Rick and Marylis haven't neglected the rest of their property; it is well landscaped with a dry creek running beside the pond and an arched bridge leading to a golf putting green on the other side of the creek. Rick says it is 65 yards from the top of the property to the main golf hole.

The Whipples had their original pond in one section of the natural creek bed. The year the County Road Department diverted rainwater from the road into the natural creek was an El Nino year and that was the end of that pond. The County won't allow them to fill in or move the natural creek, so they just enjoy the wildlife it attracts. Many different types of birds (including egrets, heron and falcons), plus squirrels, rabbits, foxes, turtles, ducks, and coyotes are on the Whipples' list of sightings.

Marylis agrees they've had fun creating their landscape, making different 'geographic' areas around the property which are inhabited by many full-sized metal animal sculptures. She lovingly mentioned 'Africa,' with an elephant, a giraffe with a sixteen-foot neck, and two of her babies; the 'Range Mountains,' with an elk and bear; and a 'Prehistoric' site where Nessie, the sea serpent, dwells. See if you can find Nessie at the meeting.

Rick has two quarantine ponds—an 850-gallon and a 1000-gallon—each with its own pump, bubble bead filter, UV and heater. The main pond is 17,000 gallons with an EPDM rubber liner and waterfalls. He has really struggled to get the equipment just right, having changed the equipment many times to get the water perfect. He uses pumps from a company called Money Saving Pumps in Colorado (<http://moneysavingpumps.com/>) and uses a device called a *variable frequency drive* that he uses to slow the motors to 60 percent. He says he can watch the meter slow when he cuts back power and can get the exact flow that he wants. He runs two 20,000-gallon bubble bead filters and a 200 watt Ultraviolet Light. Rick had to reengineer the UV because it didn't have enough flow, but it works great now.

Rick really enjoys working with metal projects, electrical challenges and just building. Marylis's passion is her quilting hobby, and she belongs to a quilting club at the Janet Goeske Senior Center. Rick and Marylis run a construction company together, which is keeping them very busy right now despite the down-turned economy.

Rick and Marylis are very excited to be hosting this meeting and their word of advice is to get all the information you can before you start your pond; it can save you a lot of money!

Although entry is from Roberts Road, the Whipples will keep the back gate open also for entrance off John F Kennedy Drive; just drive right in, staying to one side of the concrete. If you wish to park on JFK Drive, be sure to park on the same side of the street as the Whipple's house because the police will ticket your car if you park on the orange grove side.

We will see you there with our chairs, our contribution to the potluck, maybe a raffle donation and a jacket in case the wind brings a chill to the air.

Larry and Debby Leverett

Program:

WATER TURTLES with Kirk and Amy Taylor. Kirk was Past President of the Inland Empire Chapter of California Turtle & Tortoise Club, which was founded in 1964. The members are dedicated to turtle and tortoise conservation and education. Kirk is in charge of water turtle adoptions. He will discuss their habits, their diets, their life styles and may even have a few with him that will be available for adoption.

DIRECTIONS:

- Exit the 91 Fwy on **CENTRAL AVE** and go east to **TRAUTWEINE**. Go west on **JFK** about 1/2 mile to the back driveway. OR Exit I-215 on **VAN BUREN BLVD** going west.
- Follow Van Buren Blvd until you reach **WOOD ROAD**, and go north. Either go west on **JFK** pulling in the back driveway (you'll see an American Flag flying high), OR go west on **ROBERTS RD** pulling in the front driveway.
- If you choose to park on the street, make sure you park on the side the Whipple's house is on.

**18590 Roberts Road
Riverside (951) 789-0527**

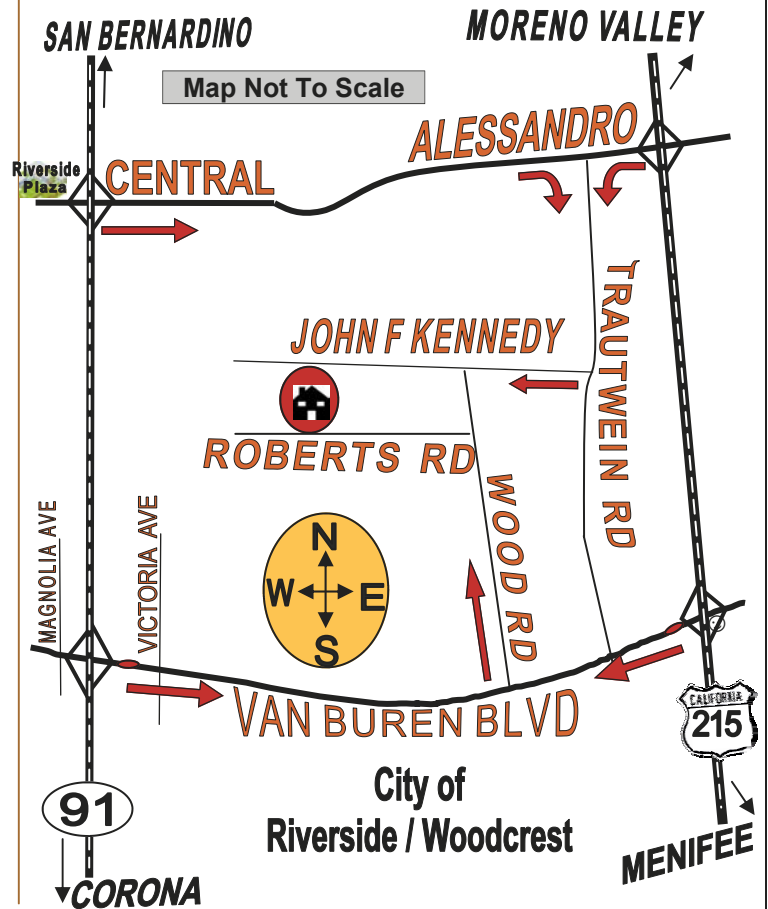

"HI" To Our Friends In Foreign Lands

This month I received a request for help from an Army wife, struggling to maintain a home, children, and job AND koi pond while her husband is away, in Afghanistan, fighting for our freedom and safety. Robbin gave us this heartwarming report: Chad is doing okay; he is just trying to stay safe and positive. It was pretty crazy over there the last few weeks, but it is getting a little better. We get to see and talk to him on Skype when they have internet, so it is really a morale booster for all of us. The girls love seeing him on the web cam. He loves to hear from everybody, especially the KOI FAMILY. While Chad is on the front line in Afghanistan, Robbin is on the front line at home. Ecological Laboratories applauds all our military and their families for the sacrifices they make and we pray they are safely reunited... soon! These guys and gals are not forgotten in the koi communities.



"Reprinted from Microbe-Lift Newsletter, publication of Ecological Laboratories, Inc. Interested parties are invited to write: Ecological Laboratories, Inc, Marketing Director, 2525 NE 9th Ave, Cape Coral, FL 33909 for more information."



BEWARE of trick-or-treating pranksters on Halloween night. This is the night I do not leave my pond, my pets, my house unattended. Many years ago, I was a kid myself, but I swear to you, I was NEVER a practical joker and certainly would not have harmed someone's fish. But on this night, unsuspecting visitors could dump toxic things into the pond or fall in while taking a short-cut through your yard. Be on the lookout for the unattended youths that might bring disaster to your pond. Be prepared for emergencies. Have on hand Microbe-Lift/PL, TheraP, ML/Aqua Xtreme, ML/Nite Out II, and Quarantine Tank Salt in case you have to set up a quarantine tank on the QT.

<http://www.microbelift.com>

"Reprinted from Microbe-Lift Newsletter, publication of Ecological Laboratories, Inc. Interested parties are invited to write: Ecological Laboratories, Inc, Marketing Director, 2525 NE 9th Ave, Cape Coral, FL 33909 for more information."

(951) 369-9998



HARRISON'S

KOI

FARM

POND KOI • SHOW QUALITY KOI

2000 KOI on display from 3" to 30"

Specializing in hard to find varieties

- KOI FOOD
- SUPPLIES
- EQUIPMENT
- CONSULTATION



Terry & Koren Harrison
5580 / 5582 Rio Road
Riverside, CA 92509

IKS GENERAL MEETING ~ SUNDAY, SEPTEMBER 27, 2009

Once again, if you missed this meeting, you missed a good one. There were 54 people at the meeting. The food just keeps getting better, and we have our generous and creative members to thank for this. Thank you, all you good cooks and thoughtful purchasers of goodies for all of us to share.

Jim and Earlene Hearn's home is spectacular. This is not a house for someone who finds comfort in a dark place for there are windows everywhere. Set atop a hill, the views are among the best and both house and garden take advantage of them. The day was a little cool but not windy; the air was clear and we could see across the valleys to the mountains behind San Bernardino.

After lunch, President Mark Krakower invited Jim to talk about the pond and garden. (The full details are in the last Inland Koi Connection.) The pond is beautiful and the fish were presented very well. This is a liner pond with the sides reinforced with steel mesh; several layers of carpet beneath the liner protect it from being punctured by rocks or debris in the soil. The pond is about 30" deep at the most, and the sides are straight to discourage predators.

Jim talked extensively about his solar fish feeder. He purchased a feeder that was originally designed to dispense grain or pellet feed in a woodland setting, throwing food in a circle pattern from a tree. He made modifications to the feeder to mount it over the pond and to limit its throwing range. The stabilization of the fish population and the feeding device allow Jim and Earlene to travel with fewer worries, and winter travel is even easier as the fish are not fed in winter. As part of the maintenance reduction effort, the old quarantine pond has been removed. In its place is a very large, tile topped wooden table with two benches. The table was well utilized and enjoyed during the meeting.

Mark introduced new members Melvin and Mary Green of Corona. The Greens have a pond that is 6 years old and they look forward to exchanging information with all of us. *Welcome to Inland Koi Society! I hope you find us to be both friendly and informative.*

Michele McKinney Underwood, Public Affairs Supervisor from Western Municipal Water District, was our speaker for the meeting. She did a very interesting presentation that included a short background on WMWD, its direct service area and the sources for their water; a discussion of our present and continuing water shortage and steps being taken to encourage conservation; and what the District and the State are doing to improve water supply, storage, and distribution. The slideshow presentation will be posted on the club website, and Michele donated several

DVD's on Waterwise Gardening to the club library for members to check out.

The message for all of us is that we are in an extended drought. WMWD obtains water from the State Water Project (which brings water to us from Northern California) and the Colorado River Aqueduct; Southern California's supply of water from both have been cut back. WMWD's direct service area is in western Riverside County—Norco, some of Corona, Woodcrest, areas down to Elsinore and Temecula—while Riverside and San Bernardino have their own water supplies. The District constructs and maintains pipelines and filtration plants, and also supplies water at wholesale to other cities and agencies, which all share water in emergencies.

Water supply and distribution in California is very complicated. We are not water independent here, even in Riverside, which has a good ground water supply. Because of the interconnected nature of the resource and the agencies, we all will face water restrictions—or worse—if this drought continues.

No one owns the water beneath their feet, at least not in California. If you wish to dispute this statement, just do some research on the history of water development, supply, and legal wrangling in California. One very good point Michele brought out was that about 80% of the water used by a normal family is used on the yard and landscaping: we are still in love with our lawns. We could save a lot of water if we used plants that needed less water, so an important part of WMWD's mission is to communicate the importance of using water as wisely as possible. In addition to providing publications, DVD's, and speakers for groups, they have an excellent demonstration garden at 450 E. Alessandro Blvd. (at Mission Grove) in Riverside. Called *Landscapes Southern California Style*™, the garden comprises about an acre and is filled with waterwise plants and ideas for several garden settings. This garden, and any information presented there, is free (Also see <http://www.wmwd.com/landscape.htm>) The garden hosts a waterwise plant sale every year, put on by the Inland Chapter of the California Association of Nurserymen to benefit its Scholarship Fund. There will be announcements in the local papers and in our Inland Koi Connection; it's a great day out for avid gardeners.

After Michele's excellent presentation, Jim Hearn and Mary Leever did the raffle, with Jim calling out the numbers. In closing, Mark announced the next IKS Board meeting would be on 10/7/09 at the Scott-Marrin Co., and the next AKCA Seminar will be in Nashville, Tennessee, May 19-23, 2010.

~ Respectfully submitted,
Zuma Ross, IKS Secretary



**LAGUNA
KOI
PONDS**

Ben Plonski

Phone (949) 494-5107
20452 Laguna Canyon Road, Laguna Beach, CA 92651
bplonski@lagunakoi.com Fax (949) 494-1679



909-981-1731
www.thepondexperts.com

**Jim Thompson
Debi Thompson**
Contr. Lic #824893

Specializing in Koi Ponds, Filtration Systems & Watergardens
LANDSCAPING • LIGHTING • ARTIFICIAL TURF / PUTTING GREENS

As many know, the Marrins and the Milfelds spent the month of September in the UK exploring Ireland, Northern Ireland, and England. We even had the opportunity to meet up with Dennis and Dorothy Lynaugh for a dinner in London; we were ending our trip and they were just beginning theirs. Although we researched Koi in the UK—a rapidly growing hobby—our planned itinerary missed every koi club and koi event: we were always in the wrong country at the wrong time. We did see a number of lovely ponds in public and private gardens, but missed every club meeting and, worse, the seventh annual Birmingham and West Midlands Koi Club Show. We were there a few days too early!

One “business” stop we made was a visit to GLEE, an annual trade show in England that embraces the nursery, landscape, garden, leisure, and pet industries. Of course, our first goal was to find the pet section and see what was offered relating to koi. There was little really new or different except some of the brand names common to the UK and Europe, but one new idea really caught our attention.

An expert koi keeper from Norfolk has designed/invented a pond-and-table combination—the “Pondable”—and is seeking some US distributors. His first concerns were the needs of the fish, then he built a table around the concept of enjoying one’s fish up close and personal. The result? A full-sized garden table that incorporates an easy-to-care-for garden pond at table-top level.

The Pondable comes in four sizes to seat from four to 16 persons. Each table encloses a heavy-grade butyl liner with a capacity of 180, 450, or 1200 liters (approx. 47.5, 119, or 317 gallons, respectively). A submersible pump, filter and UV are included, as well as feature lights, heater and other equipment specially selected for pond size, ease of use and longevity. The Pondable is “plug-in easy”—install it, add water and fish, and plug it in. (Yes, we know we wouldn’t add fish until after the filter system was ready for them!) But there’s no digging and no permanent installation; the Pondable can be repositioned or dismantled and relocated altogether. And there are removable slatted inserts that cover the ‘pond’ to expand the table area—or protect the fish. The tables are made of interlocking timber coated with high-grade satin-finish garden furniture stain in a choice of five fade-resistant colors. Solid brass fittings are used where natural movement of the wood must be allowed.

The concept was intriguing, and we immediately thought of the enterprising and creative guys in our club. More information about Pondable can be obtained by writing to admin@pondable.com, or research and view the various configurations at <http://pondable.com>.

~Peggy Milfeld



FEATURED RECIPE:

Spicy Sweet Potatoes



- 3 large sweet potatoes, peeled and cut into 1-inch cubes
- 2 tablespoons olive or canola oil
- 2 tablespoons brown sugar
- 1 teaspoon chili powder
- 1/2 teaspoon salt
- 1/4 teaspoon cayenne pepper

Step by Step:

- In a large resealable plastic bag, toss sweet potatoes and oil.
- Combine dry ingredients, add to bag and toss to coat.
- Transfer to a greased 11" x 7" x 2" baking dish.
- Bake, uncovered, at 400 degrees F for 40-45 minutes or until potatoes are tender, stirring every 15 minutes.

Yield: 8 servings

Nutritional Analysis: One serving (3/4 cup) equals 149 calories, 4 g fat (1 g saturated fat), 0 cholesterol, 164 mg sodium, 28 g carbohydrate, 3 g fiber, 2 g protein. Diabetic Exchanges: 1-1/2 starch, 1/2 fat.

This month IKS President Mark Krakower has assigned a committee to locate anyone who is interested in joining the Inland Koi Society Board of Directors.

All positions are open and will be voted on by IKS Members at the November General Meeting. Check out Officers and Directors on page two and, if you are interested in taking over or joining any position, please call Tom Wright 951-637-5479, Ed Kushner 951-520-0092, or Theo Zoetemelk 951-735-9896 for detailed information.



YUM-M-M... Our yearly November feast is **NEXT** month.

If you can come and would like to help with this special potluck meal, please sign the paper at the registration table during October’s General Meeting.

Our gracious hosts, Steve and Lily Rhodes, will cook and provide the turkey, so an attendance count is pretty important to know how much turkey to cook.

With her generous heart, Mary Leever usually provides roasted ham, and the members bring the rest of a simulated Thanksgiving meal (potatoes, salads, rolls, yams, cranberries, pumpkin pies, etc.). If you are unable to attend this meeting to sign-up, but would like to come, please call Debby Leverett, 951-781-3887 with your reservation.



"Pull One for Love"**How the Pull-Tabs Helped My Family While Going Through a Crisis**

My Fishy Friends,

I'd like to share a personal story of something that happened to my family. Perhaps it will give you a new understanding, from a different perspective, of why saving these silly little soda can pull-tabs is so important...of how they can relieve some of the financial burden a family—maybe your family—can face in a crisis. Those tabs somehow turn into outstanding people who offer shelter, meals, clean laundry, transportation, counseling and loving-kindness, and it is all free! Through them, anyone can stay close to a loved one for as long as needed throughout a crisis or illness that would otherwise devastate and destroy a family financially long after the crisis passes.

"Personal Greed"**How I Got Started Saving the Soda Can Pull-Tabs**

Years and years ago, someone told me I could make two times the amount of money from just one soda can, and would not have to increase the amount of cans I regularly recycled. All I had to do was take the tab off of each aluminum can, fill a 2-liter plastic soda bottle with them, and at a recycling center they would give \$200.00 for each full bottle. Then I could recycle the cans, getting close to the same amount of money per pound I usually got.

"Unreal! Is this true? More money with no extra effort?" I began saving the pull-tabs and, after some time (it took a lot of tabs to fill a 2-liter bottle), I finally had several bottles full. However, I could not find a place or program that recycled bottles filled with the pull-tabs or paid money for them. If that wasn't bad enough, by collecting those tabs over the years, it had become a habit for me. "This is what I get for being so greedy!"

Then it happened: an unthinkable crisis hit my family. In 1998, my nephew, Scott Nobles, a 17-year-old active senior at Sultana High School in Hesperia, woke up feeling sick. In one day he went from healthy to bedridden with an unknown virus that quickly destroyed his heart. For one month, Scott was at the Kaiser Hospital in Fontana and then was moved to the Kaiser Hospital in Hollywood, where he stayed for 97 days, waiting for a heart transplant. Scott had weighed a hefty 170, but he dropped down to 134 pounds. I remember two times, maybe more, that Scott was taken to the operating room, prepped and ready to go for his heart transplant. Then, at the last moment, Scott's doctor for some reason refused the hearts. It became an emotional roller-coaster for everyone: never knowing when a donor heart became available...whether

his doctor would accept the next heart after he had refused 23...dealing with the everyday close calls Scott endured...Scott almost dying...

Scott's Mom and Dad couldn't risk the 2-1/2 hour drive one way—even if LA's traffic allowed that quick of a

This is the house
Where families meet
To continue their lives,
To eat and sleep;
To find their strengths,
And dry their tears,
To look forward with hope
To better years.
This is the house
That becomes their home.

**This is the house
That love built.**

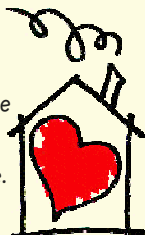

trip—to their home in Hesperia; if something happened with Scott, they could not get back to the hospital in a matter of minutes. That's when they heard about the Ronald McDonald House Charities and how they welcomed families dealing with a crisis to live in their 'homes-away-from-home.'

In addition, I learned the LA Houses desperately needed pull-tabs. They would turn in the small amounts I saw being collected to large corporations or business which in turn would shower the LA Ronald McDonald Houses with supplies, money, or whatever was needed. I didn't understand how LA Houses turned in such small quantities of pull-tabs, not weighing much, and received so much back, until it was explained to me.

The corporate businesses asked for 'tokens of good faith' (the pull-tabs) in exchange for their financial support through contributions. The pull-tabs proved both that the charity had done it's job of promoting itself and its needs, and that the public had agreed on the value of its services and the worth of supporting it. Being listed as a 'financial partner' or 'corporate sponsor' shows what a great humanitarian effort a business is making because it "gives to charities," and it's all 'free advertising.' It's also all a tax write-off.

Well! I could finally help by giving back something that's worthless to me but that did so much good for the people who were helping my family during this crisis. I remember how much the staff went on and on, so happy with the pull-tabs I gave them...and the guilt I felt when my mother-in-law wrote large checks to the LA House, donating real green money, and she didn't get as much praise as I received for the silly little pull-tabs that I had saved out of my own greed.

Scott was moved to the UCLA Medical Center on January 15, 1999, to undergo heart transplant surgery; the 5-hour-long transplant was a success. Then, after 17 days and with the ok from his doctor to leave the hospital, Scott, Mom, Dad and his younger brother, Steven, all stayed in the LA Ronald McDonald House for an additional three months, keeping Scott close to the doctors and the hospital in case his new heart was rejected during that critical time.

It is almost 11 years after receiving a heart transplant, and Scott had been healthy with no problems at all. He graduated high school and became the first and only heart transplant survivor in the nation and world to go through the rigorous Sheriff Training Academy, graduating highest in his class. Now he has a career as a Sheriff's Deputy in the Hesperia area. Scott also married and has a baby on the way, due December 7.

However, as of October 5, 2009, Scott has returned to the UCLA Medical Center showing signs of rejection. He will be put on the waiting list once again, waiting as he moves up to the #1 position for another heart transplant operation. This time it will be his little family relying on the loving-kindness of those at the Ronald McDonald House.

I hope my story has touched your hearts and explained what your silly little soda pull-tabs do for such a wonderful cause. You will see in the future what they can do for someone you know. Please keep collecting the pull-tabs; you're doing a great job. Pull them for love!

Your Fishy Friend, Chrisie Nobles



INLAND KOI

Quality Japanese Koi
& Pond Supply



Importers of high quality
Japanese koi.
Complete line of koi &
pond supplies.

**On Saturday, July 11th,
we filled our tanks with
a new shipment of Koi
from Japan. Come look!**

INLAND KOI
10000 Indiana Ave., Ste #7
Riverside CA 92503
(951) 352-5128

Look for us on the
south side of Indiana Ave.,
between Tyler and Harrison
2 miles from old location

Store Hours: Mon-Sat 10:00-5:00
Sun 10:00-4:00



Phone: (951) 352-5128

Email: inlandkoi@inlandkoi.com

THE BEST QUALITY
Japanese Koi
AT A REASONABLE PRICE!

Mazuri.

The Exotic Animal Feeding Resource

EXOTICS RULE OUR ANIMAL KINGDOM



At Mazuri®, we know exotics rule. In the grand scheme of things, we produce more food for more exotic animals than any other company in the world.

MAZURI® KOI DIETS:

- Top quality fish and soy protein
- Complete and balanced nutrition
- Astaxanthin, canthaxanthin, spirulina, shrimp and beta-carotene for brilliant color
- Each bag is date coded for guaranteed freshness and is produced in the United States



So for healthy, brightly-colored Koi and cloud-free water, trust Mazuri.®

MAZURI® KOI DIETS:
Koi Platinum Ogata
Koi Platinum Wheat Nuggets
Koi Platinum Nuggets
Koi Pond Nuggets
Koi Platinum Bits

Take a walk on the wild side and visit us at:
www.Mazuri.com

NAME	CITY	JOINED
MELVIN & MARY GREEN	CORONA	08 - 09
MARIANO & CATHY PALPALLATOC	CHINO HILLS	07 - 09
RHONDA SIMMONS & CODY SHORT	RIVERSIDE	07 - 09
ROB & LAURIE VANCE	UPLAND	10 - 09

W
E
L
C
O
M
E

IKS hopes you enjoy a fun and informative association with our club! As a member, you get the advantage of having years of experience (mistakes and lessons) available to you, while at the same time there are enough newer hobbyist members that you don't feel you are the only one who is clueless on a subject. Ask questions!



MarLu Home & Garden Design

Marc and Lucille
Chacon
951-781-6771

Award Winning Inland Empire designers will:

- Create your personal sanctuary in your own style around your pond
- Build custom seating, arbors, pergolas, and other shade alternatives
- Install all types of hard and greenscapes
- Develop your personal peaceful garden spot



With a structured plan, everyone can afford a special garden enhancement.

Leo's Construction

Driveways • Universal Flagstone • Block Wall
Brick • Ponds • Waterfalls



LEO PALOMARES

(626) 960-6157

2 Koi Guys

951 237-2508

951 205-1212



~ Scott Zehm ~ Robert Walters ~
Contractors Lic. #716692

- DESIGN • CONSTRUCTION • MODIFICATIONS
- YOUR UV LAMP SOURCE • KOI POND FILTRATION
- LINER OR CONCRETE PONDS • INSTALLATIONS
- WEEKLY & MONTHLY MAINTENANCE

Donna Keats

(951) 343-0657

(951) 529-0576

11681 Sterling Avenue
Suite H

Riverside, CA 92503
donna@pairofkeats.com
regencyseniorcare.com



Introducing our newest advertising sponsor:

LIVING SMART REGENCY SENIOR CARE

Fellow IKS members, Dennis & Donna Keats, have started a new service business.

They provide non-medical, in-your-home, personal care as well as companionship care for Seniors and others needing private care as after an injury or surgery. Their experienced employees are qualified, reliable, insured and bonded. Their purpose is to give the whole family peace of mind by respectfully taking care of the needy family member. If you have the need, they can help.

W. Lim Corporation
11095 Inland Avenue
Mira Loma, CA 91752
Tel (951) 360-7878 Fax (951) 360-1166



DRAGON Series

Industrial Baldor Motor
custom built for
W. Lim Corporation

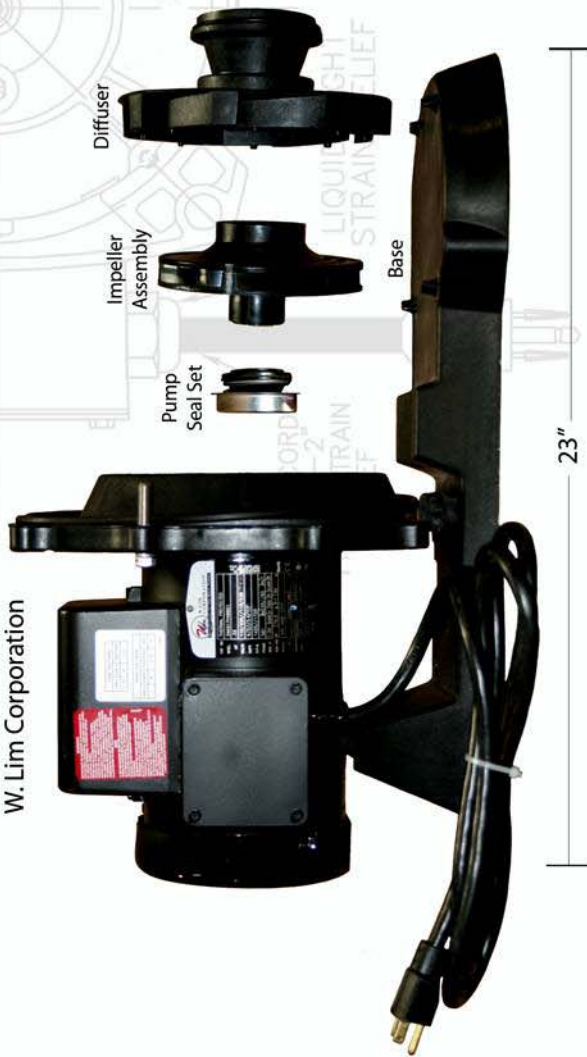

Model Shown: Dragon 1/3 HP

**INLAND KOI SOCIETY
PROGRAM PLANNING CALENDAR 2009**

REGULAR MTG 4th Sunday	HOSTS Address	PROPOSED PROGRAM Speakers	BOARD Wed. after Mtg
October 25	Rick & Marylis Whipple 18590 Roberts Road Riverside, CA 92508	WATER TURTLES with Kirk and Amy Taylor.	Oct. 28 
November 22	Steve & Lily Rhodes 26151 Carancho Rd. Temecula, CA 92590	Pending	Dec. 02

FREE

- Sunday, September 13, 2009 | 2:00 - 4:00PM
Nannette & the Hologo Togo Boys
- Sunday, September 27, 2009 | 2:00 - 4:00PM
Rocky Start
- Sunday, October 18, 2009 | 4:00 - 7:00PM
Rhythms of the East
- Sunday, November 1, 2009 | 2:00 - 4:00PM
Tonians

Bring your family, friends and picnic blankets.
Spread the word!

Edward-Dean Museum & Gardens
9401 Oak Glen Road, Cherry Valley, CA
951.845.2626
www.edward-deanmuseum.org



"Fall Back"
Nov. 1, 2009
Time Change

Discover the tranquility of a Japanese-style garden that blends design elements of classic tea, strolling and zen gardens. Cross an arched bridge and stroll on shaded paths along a koi-filled stream to the Tea House. The plant collection features Japanese maples, azaleas, bamboo, and other plants from Asia.



The Full Moon Tea House area is one of the most impressive architectural structures at Descanso Gardens. Inspired by the Asian origins of Descanso's camellias, the Japanese Garden, Full Moon Tea House and Minka bring the spirit of the Far East to California. Constructed in 1966 from funds raised by the Descanso Gardens Guild, the Japanese Garden and Tea House is the focal point of the Japanese Garden Festival every autumn. The weekend festival, November 7 & 8, 2009, features bonsai and suiseki displays, taiko drumming and traditional Japanese dancers.

The Full Moon Tea House features blue tile roofing imported from Japan. Across a Shinto bridge stand a structure resembling a Japanese farmhouse. This structure, called the Minka, was designed and donated by Robert H. Kawashima in 1969. Another nearby feature is a dry-raked garden, modeled after a Shen garden in Kyoto.

Tea is being offered at the Full Moon tea House by Patina's Café Descanso. Authentic Japanese teas, assorted beverages, and sweet and savory snacks, are offered Saturdays and Sundays from 12:00noon to 4:00pm. *Please note:* Weekend tea service at the Full Moon Tea House starts the end of March and runs through the end of November.

A more extensive tea service is available between 12:30 and 3 p.m. Saturdays and Sundays. This sit-down service, for which reservations are required 48 hours in advance and may be arranged by calling Patina at (818) 790-3663. Guests are welcomed without reservations when space is available.

FULL MOON HOUSE - TEA SERVICE MENU/FULL MOON HOUSE - TEA SERVICE MENU
Beverage: 1 pot of loose leaf tea / **Starter:** Miso Soup
Savories: Open face Teriyaki Chicken Sandwich w/Watercress/Roasted Shitake Mushroom & Seaweed Salad/Tofu Spring Roll/
California Roll/Spicy Tuna Roll/ **Dessert:** Asian dessert/ **Price:** \$19.50 pp, plus tax and service charge. Sake, Asahi beer and various a la carte items will be available as well.

1418 Descanso Drive, La Cañada Flintridge, CA 91011 / Admission: General \$8. Senior/Students \$6. Children (5 to 12 years) \$3./ For further assistance or have a question about the Gardens, please call (818) 949-4200. www.descansogardens.org



Coming Events

2009

- 18 **OUTDOOR MUSIC & JAZZ FESTIVAL** ~ 4-7pm. See information on the left
- 23-25 **BAKERSFIELD KOI & WATER GARDEN** ~ Annual Koi Show at Kern County Fairgrounds, Bakersfield CA. Contact Gini Cope 661-399-6195 ginic@bak.rr.com
- 25 **IKS GENERAL MEETING AND POTLUCK** ~ 2-5 pm Hosts will be Rick & Marylis Whipple in Riverside For more information, contact Mark Krakower at (951) 371-2223
- 28 **IKS BUSINESS MEETING** ~ 7 pm / *All members of IKS welcome!* — 6531 Box Springs Blvd, Riverside / Mark Krakower at (951) 371-2223.
- 31 **CHRYSANTHEMUM SHOW** ~ 9am-1pm. the Earl Burns Miller Japanese Garden on the campus of California State University Long Beach - (562) 985-8885 www.csulb.edu/~jgarden
- 31 **HALLOWEEN ~ BOO TO YOU!**
~ BE SAFE ~ HAVE FUN~ 



N O V E M B E R

- 01 **TIME CHANGE** ~ It's that time again. Turn your clocks back 1 hour before going to bed. Z-Z-Z-Z-Z
- 01 **OUTDOOR MUSIC & JAZZ FESTIVAL** ~ 4-7pm. See information on the left
- 07-08 **JAPANESE GARDEN FESTIVAL** ~ Brings the sights and sounds of traditional music and horticulture to Descanso Gardens every autumn. Activities range from the thundering sounds of taiko drums to the tranquil, meditative quality of Ikebana. All evoke the culture of Japan/9am-5pm/(818) 949-4200.
- 13 **AKCA BOARD MEETING** ~ 6pm / 529 W. Blueridge Ave., Orange, CA 92865 / Call Kelly Houston at (909) 885-2503 for more information.
- 14-15 **ZNA NORTHERN CALIF.** ~ Chapter Annual Koi Show Holiday Inn - San Jose, CA/ contact Barbara Jackson barbjp@gmail.com
- 22 **IKS GENERAL MEETING AND POTLUCK** ~ 2-5 pm / This will be the FINAL meeting in 2009 and IKS tradition calls for a Thanksgiving Pot luck. Hosts will be Steve & Lily Rhodes in Temecula. For more information, contact Mark Krakower at (951) 371-2223
- 26 **THANKSGIVING DAY** ~ Be Thankful for what you have :) 
- Apple **APPLE BUTTER FESTIVAL** ~ 9am-5pm / Free/ Riley's at Los Rios Rancho in Oak Glenn. We'll have a hands-on demonstration of apple butter making the old-time (and slow!) way - outdoors in a big copper kettle. Plus enjoy pioneer crafts and games, music, carriage rides, and lots more. On Saturday we'll cap off the evening just like our ancestors did. Chuckwagons will prepare a pumpkin stew for the Apple Butter Hoedown. The chuckwagons will be using the apple butter we cook up to create their own unique dishes – come taste and vote on Sunday. 39611 Oak Glen Rd., #13 Oak Glen, CA 92399 - (909) 797-1005 www.losriosrancho.com
- 27-28-29 

The Inland Koi Connection is a publication of the Inland Koi Society. Material is selected for the club's interest in ponds, koi, gardening, and other activities. IKS Officers and Directors accept no responsibility for accuracy of content. Reproduction is permitted provided this newsletter is credited as the source. Deadline for newsletter items is the 5th day of each month and items should be submitted directly to Editor, Debby J. Leverett at 5349 Jasper Lane - Riverside, California 92506 Phone: (951) 781-3887 E-mail: jenniferd11950@hotmail.com



INLAND KOI SOCIETY
5198 ARLINGTON AVE., #146
RIVERSIDE, CA 92504

Return Service Requested



“But Ma-ma... I don't want to dress-up like a skeleton for Halloween; let Johnny be that. I want to be a Dalmatian like Hector!”

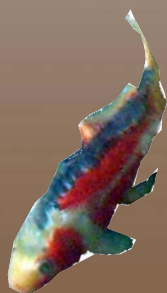
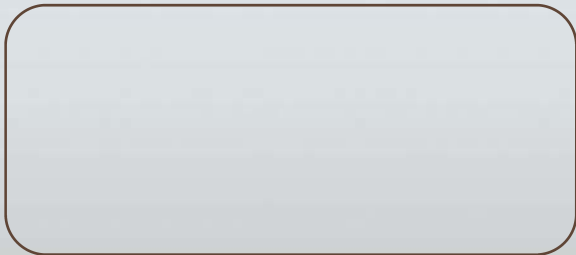

Visit our website: www.inlandkoi.org